



TechBook

in.k300

the essential spa keypad



Bright LCD screen

Spa function icons

Affordable





Table des matières

| | |
|--|----|
| Warnings | 2 |
| Introduction | 3 |
| in.k300 keypad layout | 4 |
| in.k300 dimensions | 4 |
| Installation of in.k300 | 4 |
| Drilling template | 5 |
| Installation notes | 6 |
| Connecting in.k300 keypad to the spa pack | 6 |
| Keypad functions | 7 |
| - Start or stop accessories | 7 |
| - Water temperature | 7 |
| - Off Mode | 7 |
| Programming steps | 8 |
| - Program menu | 8 |
| - Setting the clock | 8 |
| - Programming the filter/ purge cycles | 8 |
| - Setting filter or purge cycle start time | 9 |
| - Setting filter cycle duration | 9 |
| - Setting filter or purge cycle frequency | 9 |
| - Setting economy mode* | 9 |
| - Setting economy start time* | 9 |
| - Setting economy duration* | 10 |
| - Setting temperature unit | 10 |
| - Smart Winter Mode | 10 |
| - Cooldown | 10 |
| - Water temperature regulation | 10 |
| Error messages | 11 |
| Specifications | 12 |



Warnings



WARNINGS:

Before installing or connecting the unit, please read the following.

FAILURE TO COMPLY WITH THE FOLLOWING WARNINGS MAY SIGNIFICANTLY SHORTEN THE PRODUCT'S LIFE TIME, AND LEAD TO FAILURES AS WELL AS HAZARDOUS CONDITIONS*. COMMON SENSE MUST ALWAYS PREVAIL WHEN EVALUATING THE INSTALLATION AND/OR USE OF ANY ELECTRONIC CONTROL IN A FINAL APPLICATION.

- RESPECT ENVIRONMENTAL CONDITIONS LISTED AT END OF TECHBOOK.
- THIS UNIT MUST BE INSTALLED BY QUALIFIED PERSONNEL.
- ONLY QUALIFIED PERSONNEL ARE TO SERVICE THIS UNIT. THERE ARE NO USER SERVICEABLE PARTS INSIDE.
- THIS UNIT SHOULD BE INSTALLED ON A CLEAN FLAT SURFACE.
- THE GASKET ON THE BACK OF THE UNIT WILL PREVENT WATER INFILTRATION INSIDE, BEHIND THE MOUNTED SURFACE. IF THE GASKET IS DAMAGED, SEAL THE BACK OF THE UNIT WITH SILICONE TO AVOID ANY LEAKAGE BEHIND THE MOUNTED SURFACE.
- THIS UNIT MUST BE MOUNTED ON THE OUTSIDE EDGE OF THE SPA. SEE INSTALLATION SECTION FOR DETAILS.
- THE BACK OF THIS UNIT SHOULD NOT BE ENCLOSED IN A WAY THAT CAUSES WATER TO COLLECT. SEE INSTALLATION SECTION FOR DETAILS.

* HAZARDOUS CONDITION:

A CONDITION THAT IS POTENTIALLY DAMAGING AND/OR DANGEROUS TO THE OPERATOR OR SURROUNDINGS. THIS INCLUDES, BUT IS NOT LIMITED TO: FIRE, FLOODING OR OTHER WATER DAMAGE, DIELECTRIC BREAKDOWNS (PRESENCE OF HIGH VOLTAGE), ETC.

MAINTENANCE

If you have problems, do not attempt to repair the unit yourself. Return it to your dealer or service station for servicing

ACCESSORY PARTS

Be sure to use only the specified accessory parts. Use of other than designated parts may damage this unit internally or may not securely install the unit in place. This may cause parts to become loose resulting in hazards or product failure.

DISPOSAL OF THE PRODUCT

The appliance (or the product) must be disposed of separately in accordance with the local waste disposal legislation in force.



Compatible spa packs:

in.xm2, in.xe, in.yt, in.yj, and in.ye with compatible software revision.

Aeware®, Gecko®, and their respective logos are Registered Trademarks of Gecko Alliance Group. in.k300™, in.xm2™, in.xe™, in.yt™, in.ye™, and in.yj™ and their respective logos are trademarks of Gecko Alliance Group.

All other product or company names that may be mentioned in this publication are tradenames, trademarks or registered trademarks of their respective owners.

Introduction



in.k300 the essential spa keypad

The in.k300 brings all the features you really need to one keypad. Compact, with a big LCD screen; bright enough to be seen in day, simple enough to use in the middle of the night; affordable, yet solidly built.

| Item | in.k300 |
|--|---------|
| Static LCD size (as measured diagonally) | 1.5" |
| Optional mounting with wing-nuts and spacers | ● |
| Double-sided bezel gasket | ● |
| Icons giving instant spa status information | ● |
| Number of pumps/blowers supported | 1 or 2 |
| Time display | ● |



in.k300 keypad layout

1 Pump Model

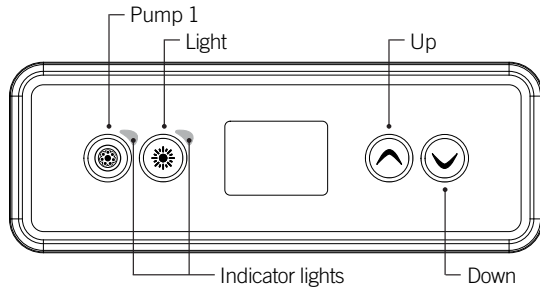

2 Pump Model

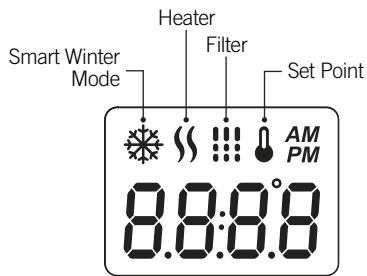
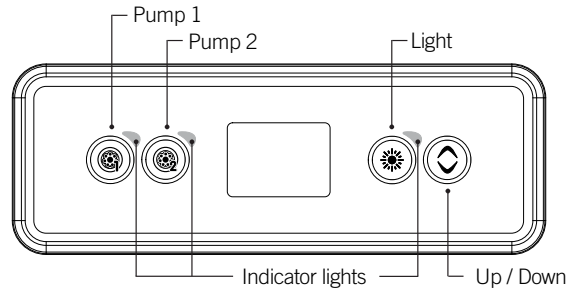

in.k300 dimensions

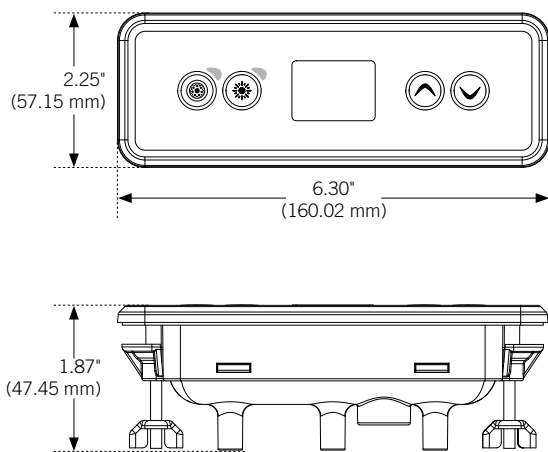

Installation of in.k300

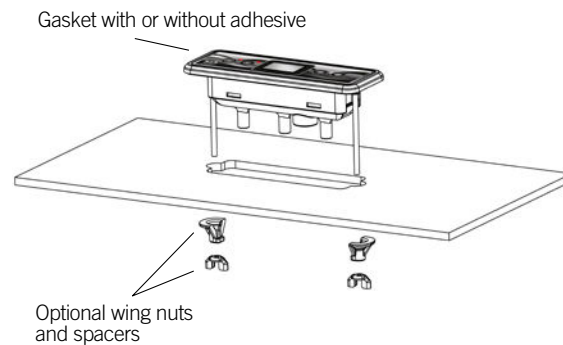

To install the in.k300, use the drilling template provided in this section.

Determine the mounting location and stick the template on chosen location.

Cut out an opening according to the template.

Clean the installation surface and peel the adhesive gasket from the back of the keypad.

Insert keypad and align it correctly, then ensure it is properly glued by gently pressing evenly on the entire surface.

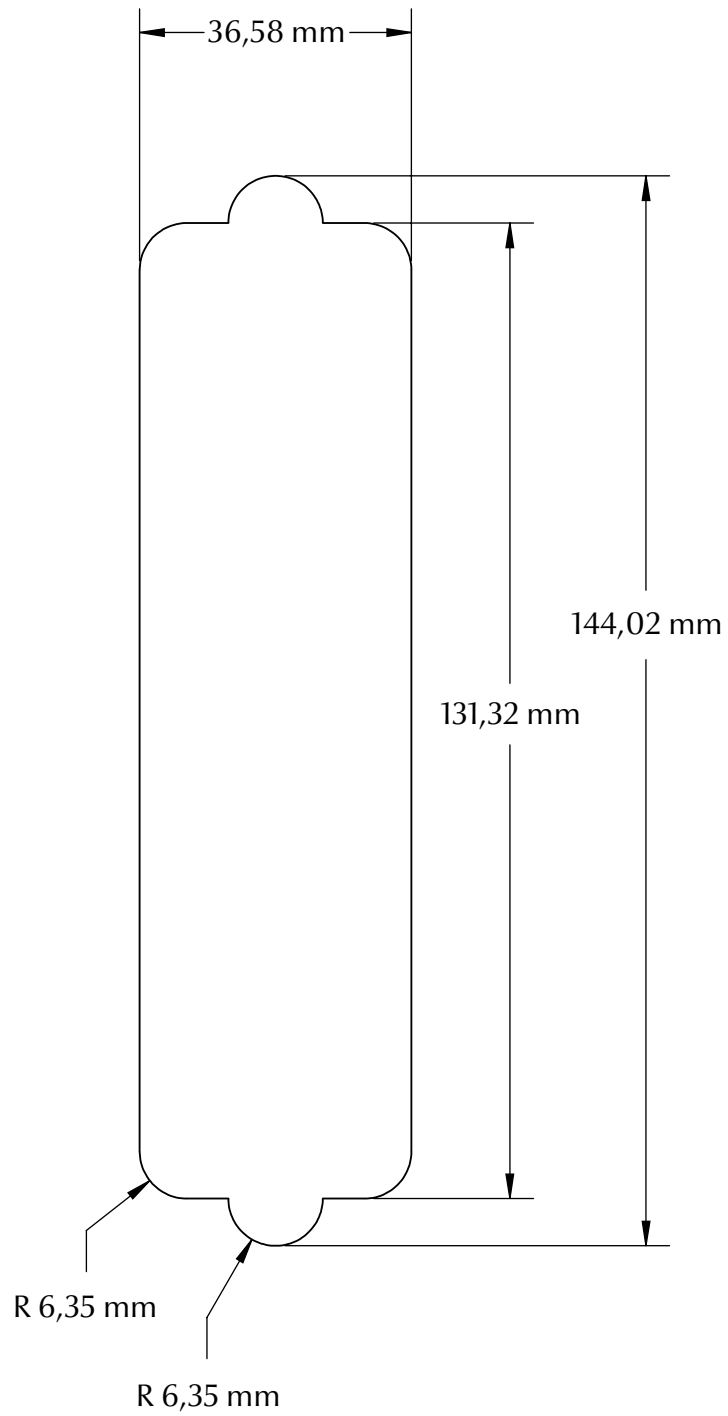



Installation notes

Keypad placement

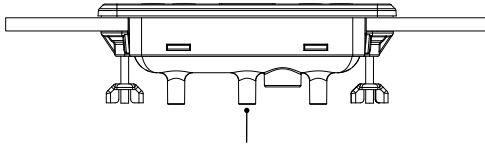

Vent hole on back of keypad should not be blocked.

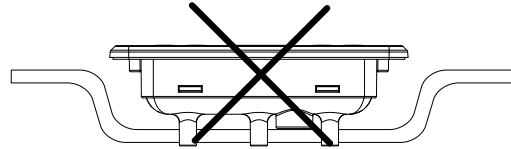

The back of the in.k300 should not be enclosed where water can gather, but instead cut out.

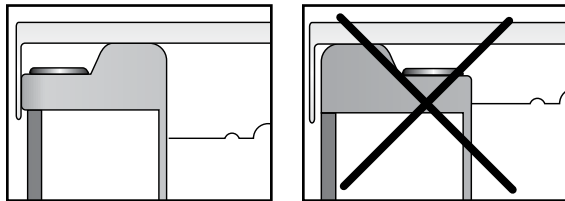

It is recommended to install the in.k300 on the outside edge of the hot tub, so that it is not subject to moisture trapped by the cover.

Connecting in.k300 keypad to the spa pack

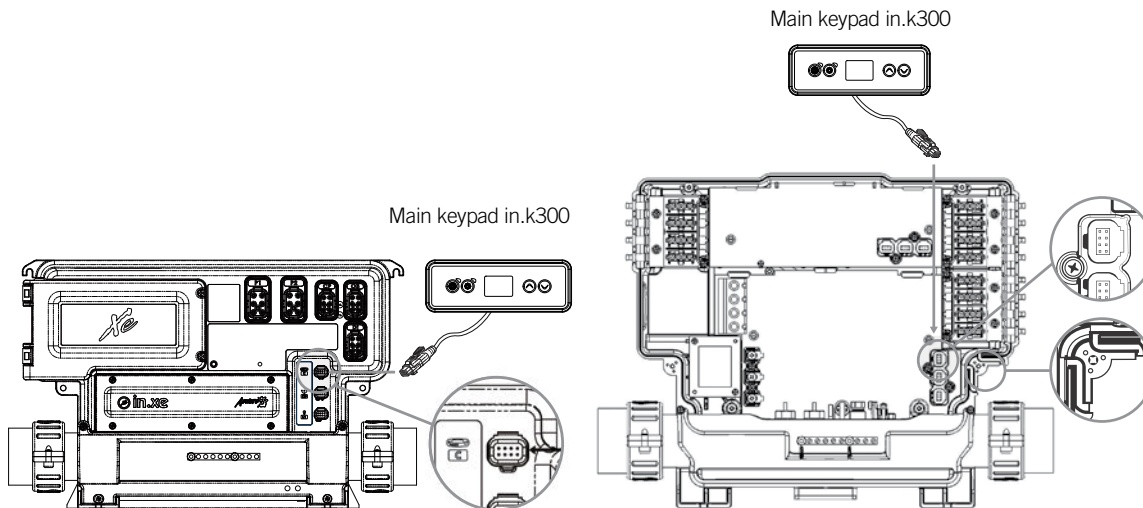

in.xe & in.xm 2

To connect the in.k300 keypad, simply insert its in.link connector into the appropriate keypad connector of the pack enclosure (as illustrated).

in.ye & in.yt

To connect the keypad, remove the cover, then insert the in.link connector into the appropriate keypad connector (as illustrated). Route the cable through one of the molded strain relief channels on the bottom right side of the spa pack (as illustrated). Fill the remaining space with the foam gaskets supplied. Don't forget to replace the cover and all screws (torque to 8 in. lb max (0.9 N.m)).

Keypad functions

Start or stop accessories

To start or stop an accessory, press the associated button. Indicators will light up when the associated accessory is on.

When an accessory has more than two states, press the button until it reaches the desired state. Indicators will flash when dual speed pumps are on at low speed, and will be solid at high speed.

If you have a blower it will be controlled by the **Pump 2** key. The order of actions is as follows: pump 2 on; pump 2 high speed (if applicable); blower on; pump 2 off; blower off.



Water temperature

The temperature shown on screen is the current water temperature. Use the **Up** and **Down** buttons to set the desired temperature.

The set point icon will appear at the top of the screen. After 3 seconds without any change to the set temperature value, the keypad will resume the normal display.



Off Mode

Pressing Pump 1 for 5 seconds will enable the Off mode. This mode allows you to stop all outputs including automatic functions such as filter cycle, heat request and smart winter mode for 30 minutes to perform quick spa maintenance. When Off mode is active, the display will toggle between the "OFF" message, the clock and the water temperature. The spa light will flash for a few seconds before the end of the 30 minutes to warn you that the system is about to resume its normal operation. Press Pump 1 or Pump 2 (if available) to restart the system before the expiration of the 30 minute delay. When the system resumes its normal operation, the display shows "On" for 3 seconds.



Programming steps



Program menu

The program menu is accessible by holding down the **Light** key for 5 seconds. In the program menu the following parameters can be set: clock, filter or purge cycles, economy mode and temperature units. While in the program menu, use the **Up** or **Down** key to adjust the parameters and use the **Light** key to jump to the next parameter. The changes will be saved after the confirmation of the last parameter only. If there is no action taken for 10 seconds, the system will exit the program menu without saving any changes.



Setting the clock

Enter the program menu by holding down the **Light** key for 5 seconds. The display will show the current clock setting with the hour flashing.

Depending on factory settings your system may be set to 24-hour time or 12-hour time.

Setting the hour: Use the arrow keys to adjust the hour. Press the **Light** key to jump to the next parameter, the minutes.

Setting the minutes: Use the arrow keys to adjust the minutes. Press the **Light** key to jump to the next parameter, the filter or purge start time (FS).

Programming the filter/ purge cycles

Depending on system configuration your spa will perform either a filter or a purge cycle. The filter cycle menu consists of the following parameters: the start time (FS), the duration (Fd) and the frequency (FF). The purge cycle menu consists of the following parameters: the start time (FS) and the frequency (FF).

A filter cycle consists of starting all the pumps and blower in high speed for 1 minute (purge step) then, the pump associated with the filter will run in low speed for the remaining duration of the filter cycle (clean step).

A purge cycle is used when the spa is equipped with a 24 hour circulation pump which provides a continuous clean step. It consists of starting all the pumps and blower in high speed for 1 minute.

Programming steps



Setting filter or purge cycle start time

The display will show FSxx, “xx” representing the starting hour of the cycle. Use the arrow keys to adjust the hours. Use the **Light** key to jump to the next parameter, filter duration (Fd).



Setting filter cycle duration

(not available on purge systems)

The display will show Fdxx, “xx” representing the duration in hours of the filter cycle. Use the arrow keys to adjust the duration. Use the **Light** key to jump to the next parameter, filter or purge frequency (FF).

0 = no filtration

24 = continuous filtration

It is not recommended to set this to "0".



Setting filter or purge cycle frequency

The display will show FFxx, “xx” representing the number of cycles per day. Use the arrow keys to adjust the frequency. Use the **Light** key to jump to the next parameter, economy mode (EP).

 The “Filter” indicator lights up when filter is on and flashes when suspended.



Setting economy mode*

This mode allows you to lower the temperature set point of the spa by 20 °F (11 °C) during a certain period of the day.

The display will show EPx, “x” representing the state of the programmed economy (0 = disabled, 1 = enabled). Use the arrow keys to enable or disable economy mode. Use the **Light** key to jump to the next parameter, economy start time (ES). When the Economy mode is ON, the display will toggle between the “Eco” message, the time, and the water temperature.



Setting economy start time*

The display will show ESxx, “xx” representing the hour at which the economy mode will become active. Use the arrow keys to adjust the hour. Use the **Light** key to jump to the next parameter, economy duration (Ed).

* Note that the parameters for the economy mode settings are associated to specific low level configuration of the system that are not present in all software revisions.



Programming steps



Setting economy duration*

The display will show Edxx, “xx” representing the duration in hours of the economy mode. Use the arrow keys to adjust the hour. Use the **Light** key to jump to the next parameter, temperature unit.

24 = continuous economy



Setting temperature unit

Water temperature can be displayed in either Fahrenheit (°F) or Celsius (°C). The display will show °F or °C.

Use the arrow keys to change the setting.
Use the **Program** or **Light** key to save all the parameters.



Smart Winter Mode

Our Smart Winter Mode protects your system from the cold by turning pumps on several times a day to prevent water from freezing in pipes.



The “SWM” indicator lights up when freezing is detected and flashes when the purge is active.

Cooldown

After heating the spa water to the desired Set Point, the heater is turned off, but its associated pump (Pump 1 low-speed or CP) remains on for a predetermined period of time to ensure adequate cooling of the heating element, prolonging its useful life.



Water temperature regulation

Every 15 to 90 minutes the pump will run to ensure accurate water temperature readings as well as avoid heater activation in dry conditions. After verifying pump activation and taking a water temperature reading if required, the system automatically turns the heater on to reach and maintain water temperature at Set Point.



Indicator flashes when taking water temperature reading.

* Note that the parameters for the economy mode settings are associated to specific low level configuration of the system that are not present in all software revisions.



Error messages

The list below shows the different error messages that can appear on the home screen.
Refer to the troubleshooting and error codes section of the TechBook for your spa pack for more details.

| Code | Message |
|-------|--|
| HL | Warning! HL Error |
| FLO | No flow for more than 2 hours |
| FLO | No flow condition |
| HR | Danger! Relay stuck |
| OH | Warning! Spa temp. high |
| Prr | Warning! Temp. probes defective |
| AOH | Internal pack temp. high |
| FLC | Flow switch closed |
| SP in | Input voltage issue |
| FrEr | The input frequency is out of range |
| RH NC | Comm. error in.xm2 - in.therm |
| RH ID | in.xm2 - in.therm incompatible |
| SC ER | Learning mode error |
| F1 | in.xm2 Fuse # 1 is blown |
| F2 | in.xm2 Fuse # 2 is blown |
| F3 | in.xm2 Fuse # 3 is blown |
| Hr | Danger! Thermal fuse error |
| UPL | The spa pack does not have valid software. Please insert valid in.stick to reprogram spa pack. |
| BL | The spa pack does not have valid software. Please insert valid in.stick to reprogram spa pack. |



Specifications

Part number

1 pump model: 0607-008036

2 pump model: 0607-008037

Model

IN.K300-CL-GE1

Environmental

Operating temperature: -68°F (-20°C) to 149°F (65°C)

Storage temperature: -22°F (-30°C) to 185°F (85°C)

Humidity: Up to 70% condensing

Water ingress protection: IPX-5

Mechanical

Weight: 0.69 lb (313 g)

Dimensions (W x H x D): 2.25" x 6.30" x 1.87" (57.15 mm x 106.02 mm x 47.45 mm)

Compatibility

in.yj, in.yt, in.ye, in.xe, or in.xm2 spa packs with appropriate software revision



9919-101218-D
Rev. 02-2018

© Groupe Gecko Alliance Inc., 2018
All trademarks or registered trademarks
are the property of their respective owners.

Gecko Alliance
450 des Canetons, Québec (Qc), G2E 5W6 Canada, 1.800.78.GECKO
www.geckoalliance.com

Printed in Canada